

SVB-SERIES VALVES (UL 842 Approved)



*Underwriter Listed
*ANSI, UL-842 Approved
"Valves for Flammable Fluids"

APPLICATION

The Fulflo SVB - Series, Underwriter Listed, range in size from 3/8" through 2" and operate efficiently with liquids of any viscosity at pressures from 3 through 500 P.S.I. The "SVB" valves are of brass construction with threaded connections.

Primarily designed for use with fuel oils on oil burner service, the "SVB" valves may be used wherever Underwriter Listed valves are required. Each valve is pre-set to the specified pressure and is equipped with a limiting device to prevent over-adjustment.

INSTALLATION

Fulflo valves can be mounted in any position. A tee may be inserted in the pump discharge line to mount the valve. The correct size of valve should be installed, preferably matching the pump discharge line. Screw the valve into the nipple in the tee. When the valve is used for frequent bypassing of oil under pressure, its outlet should be piped back to the tank. Care

must be taken to have the discharge well below the oil level in the tank to prevent air entrainment and erratic operations.

Only if the valve is used as safety or overload relief and operates infrequently may its discharge be piped back into the pump suction line. Frequent or continuous operation under these conditions will cause excessive heating of the oil and possible damage.

SVB-SERIES

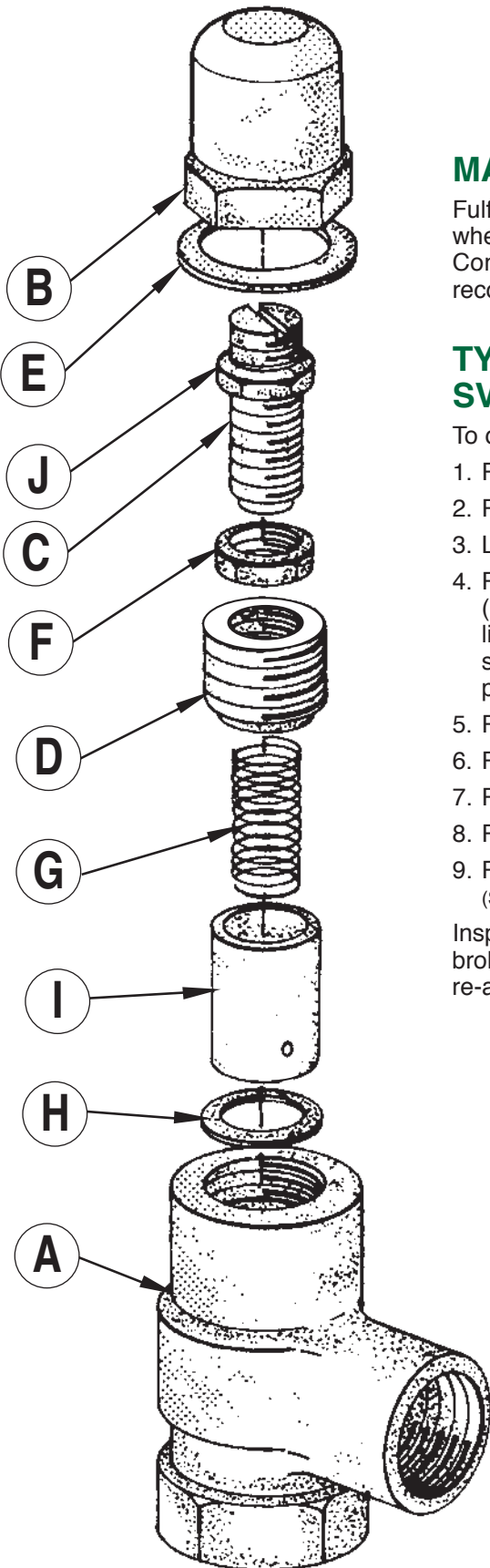

MAINTENANCE

Fulflo valves provided reliable “chatter-free” operation when the system is free of abrasives and foreign matter. Continuous filtration of the liquid used is strongly recommended.

TYPICAL DISASSEMBLY OF SVB VALVES

To dismantle valve for inspection and cleaning:

1. Remove cap “B”
2. Remove gasket “E” (replace, if necessary)
3. Loosen lock nut “F”
4. Remove adjusting screw “C”
(Limit collar “J” is soldered to adjusting screw “C”, to limit the maximum pressure to which the valve may be subjected.) Limit collar is set at 25% above normal pressure setting.
5. Remove lock nut “F”
6. Remove retainer “D”
7. Remove spring “G”
8. Remove piston “I”
9. Remove stop ring “H” (Not Recommended)
(Special tooling is required to install new stop ring.)

Inspect valve bore and piston for wear or scoring. Replace broken or damaged parts. Clean all parts thoroughly and re-assemble by reversing the above procedure.

SVB-SERIES

ASSEMBLY NUMBER IDENTIFICATION CHART

Symbol Number	Designation	Code	Description
1	Style	S	Underwriter Listed
2	Series	V	—
3	Material	B	Brass
4 or 5	Size	-25 -35 -45 -55 -65 -75 -85	3/8" 1/2" 3/4" 1" 1 1/4" 1 1/2" 2
6	Spring	See Chart	See Spring Pressure Chart
7	Piston	0 1 2 3	Hardened Steel, deep groove Stainless Steel, deep groove Hardened Steel, shallow groove Stainless Steel, shallow groove

EXAMPLE:

SVB-55ZSO					
S	V	B	-55	ZS	O
Underwriter's Listed	Series	Brass	1"	Spring	Hardened Steel Piston, Deep Groove

HOW TO ORDER

Specify:

1. Valve Model Number
2. Spring Letter
3. Piston Number
4. Pressure Setting

NOTE: A definite pressure setting is required due to Underwriter restrictions. A limiting device is furnished to prevent over-adjustment more than 25% above set pressure.

SETTING VALVES

Valve may be set with a hand pump for cracking pressure. It will be noted that the maximum set pressure is limited by the collar "J" soldered to the adjusting screw "C".

If a test stand is available, valve should be connected to the discharge header with the pump bypass open, and the bypass gradually closed until the desired pressure registers on the gauge. Adjust valve adjusting screw until valve slightly bleeds at the set bypass pressure and lock adjusting screw.

If valve is required to bypass a given amount of fluid at a given pressure, a test stand having a flow meter in the pump discharge line must be available. With valve adjusted for cracking pressure as above, continue closing bypass until the required flow registers on the flow meter and observe pressure. Re-adjust pressure, if necessary, to obtain desired pressure at desired flow.

UNDERWRITER VALVE PRESSURE RANGE CHART

Pipe Size	"U.L." Symbol	SPRING PRESSURE RANGE AND PART NO. SUFFIX											
		BLACK -AS		RED-US		GREEN-WS		YELLOW-XS		WHITE-YS		BLUE-ZS	
		Low	High	Low	High	Low	High	Low	High	Low	High	Low	High
3/8"	SVB-25	3	10	7	35	30	100	60	175	150	350	300	500
1/2"	SVB-35	3	10	7	35	30	100	60	175	150	350	300	500
3/4"	SVB-45	3	10	7	35	30	100	60	175	150	350	300	500
1"	SVB-55	3	10	7	35	30	100	60	175	150	350	300	500
1 1/4"	SVB-65	3	10	7	35	30	100	60	175	150	350	300	500
1 1/2"	SVB-75	3	10	7	35	30	100	60	175	150	350	300	500
2"	SVB-85	3	10	7	35	30	100	60	175	150	350	250	600

SVB-SERIES (Brass)

DIMENSIONS

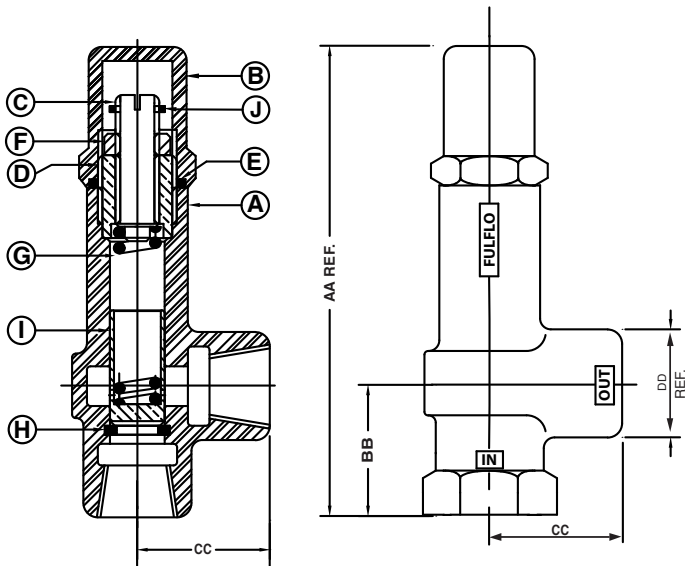

Pipe Size	"U.L." Symbol	DIMENSIONS IN INCHES			
		AA	BB	CC	DD REF.
3/8"	SVB-25	5 ¹¹ / ₃₂	1 ³ / ₈	1 ³ / ₈	1 ³ / ₈
1/2"	SVB-35	6 ³ / ₁₆	1 ¹¹ / ₁₆	1 ⁷ / ₁₆	1 ⁷ / ₁₆
3/4"	SVB-45	6 ¹⁵ / ₁₆	1 ¹⁵ / ₁₆	1 ¹³ / ₁₆	1 ¹¹ / ₁₆
1"	SVB-55	8 ⁷ / ₃₂	2 ⁹ / ₃₂	2 ⁹ / ₃₂	2 ¹ / ₁₆
1 1/4"	SVB-65	9 ⁹ / ₁₆	2 ⁹ / ₁₆	2 ⁹ / ₁₆	2 ¹ / ₂
1 1/2"	SVB-75	11 ¹¹ / ₁₆	2 ¹¹ / ₁₆	2 ¹¹ / ₁₆	2 ⁷ / ₈
2"	SVB-85	13	3	3	3 ¹ / ₄

PARTS LIST

Symbol	NAME	VALVE SIZE						
		3/8"	1/2"	3/4"	1"	1 1/4"	1 1/2"	2"
A	Body	200-B	300-B	400-B	500-B	600-B	700-B	800-B
B	Cap	201-B	301-B	401-B	501-B	601-B	701-B	801-B
C	Adjusting Screw	202-B	302-B	402-B	502-B	602-B	702-B	802-B
D	Retainer	203-B	303-B	403-B	503-B	603-B	703-B	803-B
E	Gasket	204	304	404	504	604	704	804
F	Lock Nut	205-S	305-S	405-S	505-S	605-S	705-S	805-S
G	Spring	See Chart	See Chart	See Chart	See Chart	See Chart	See Chart	See Chart
H	Stop Ring	208-B	308-B	408-B	508-B	608-B	708-B	808-B
I	Piston H.S. Deep Groove S.S. Deep Groove H.S. Shallow Groove S.S. Shallow Groove	206-G 206-AG 206 206-A	306-G 306-AG 306 306-A	406-G 406-AG 406 406-A	506-G 506-AG 506 506-A	606-G 606-AG 606 606-A	706-G 706-AG 706 706-A	806-G 806-AG 806 806-A
J	Limit Collar	221-B	321-B	421-B	521-B	621-B	721-B	821-B

SVB-SERIES PERFORMANCE CHARTS

All valve tests 110°F. to 120°F. Oil Viscosity 150 S.S.U. at 100°F.
(Charts good from 30 to 500 S.S.U.)

3/8" VALVE TESTS

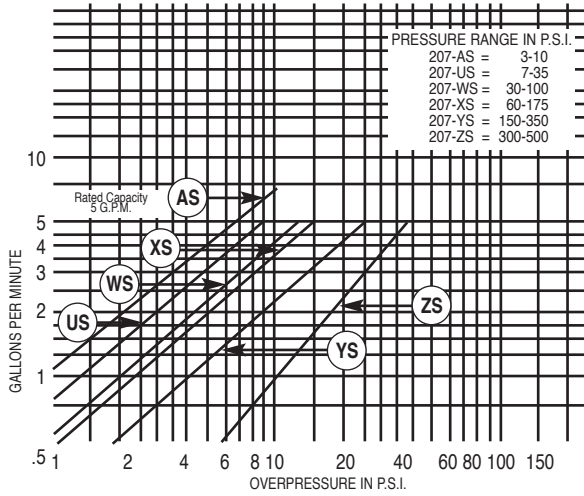

1/2" VALVE TESTS

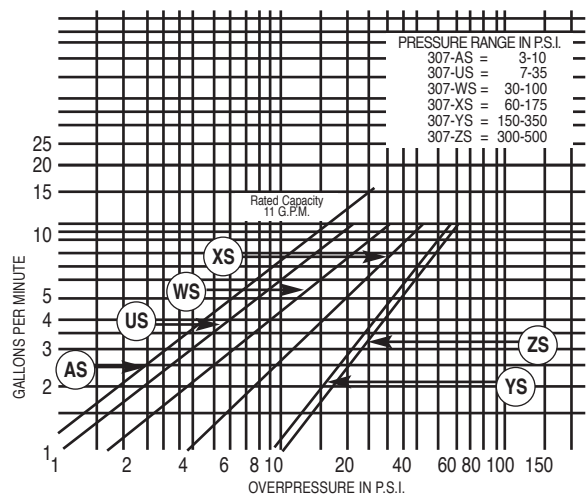

3/4" VALVE TESTS

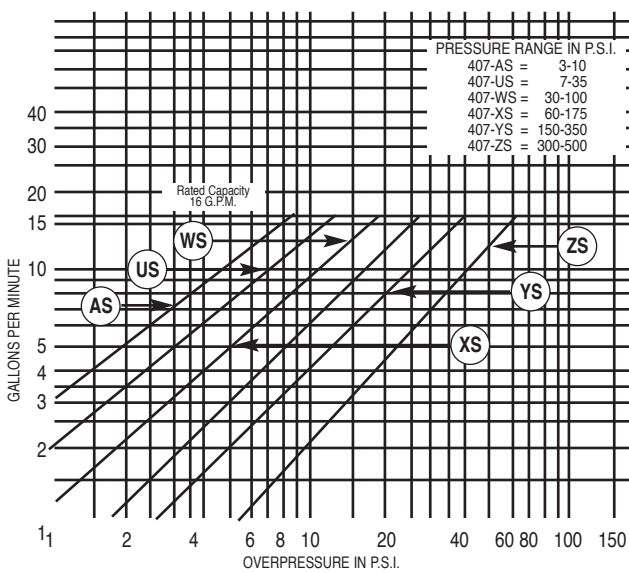

1" VALVE TESTS

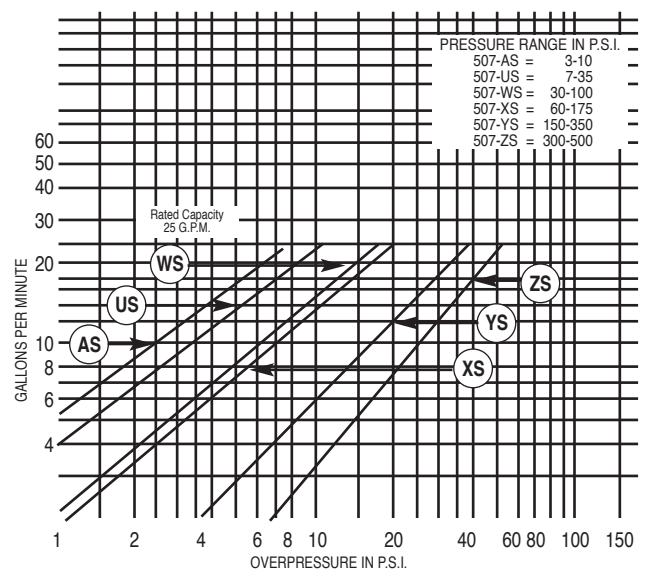

Overpressure - The pressure increase or accumulation above the set pressure when the valve is discharging flow.

SVB-SERIES PERFORMANCE CHARTS

All valve tests 110°F. to 120°F. Oil Viscosity 150 S.S.U. at 100°F.
(Charts good from 30 to 500 S.S.U.)

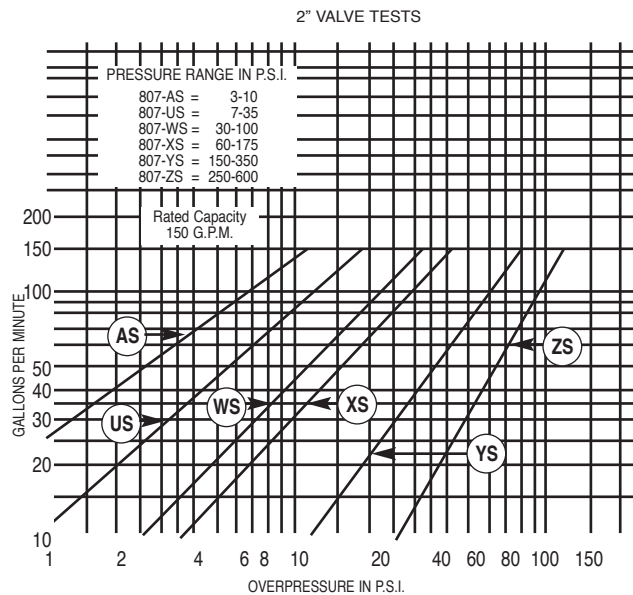
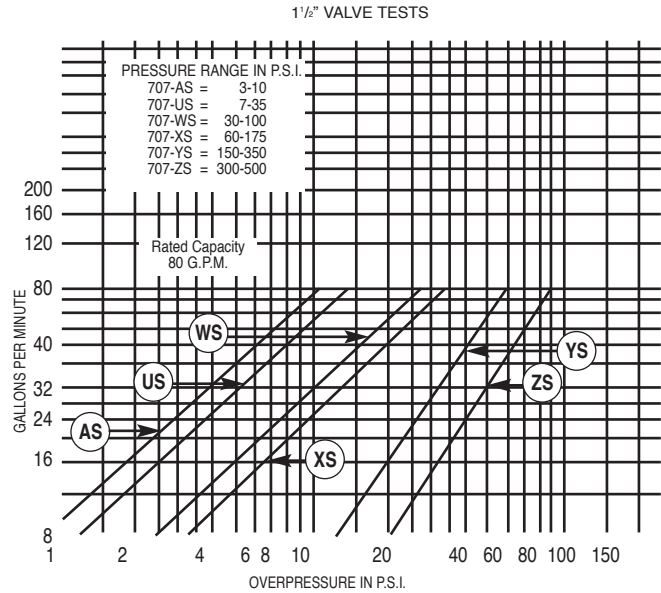
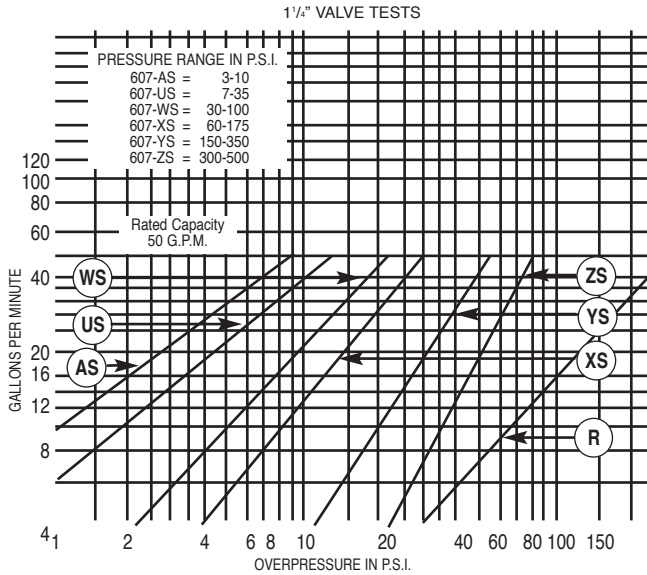

Overpressure - The pressure increase or accumulation above the set pressure when the valve is discharging flow.